



Austrian Institute of Construction Engineering
Schenkenstrasse 4 | T+43 1 533 65 50
1010 Vienna | Austria | F+43 1 533 64 23
www.oib.or.at | mail@oib.or.at



European Technical Assessment

ETA-20/0991
of 28.12.2020

General part

Technical Assessment Body issuing the European Technical Assessment

Österreichisches Institut für Bautechnik (OIB)
Austrian Institute of Construction Engineering

Trade name of the construction product

Hilti Firestop Cushion CFS-CU

Product family to which the construction product belongs

Fire Stopping and Fire Sealing Products:
Penetration seals

Manufacturer

Hilti AG
Feldkircherstrasse 100
9494 Schaan
LIECHTENSTEIN

Manufacturing plant

J/022

This European Technical Assessment contains

19 pages including Annexes A to D which form an integral part of this assessment

This European Technical Assessment is issued in accordance with Regulation (EU) No 305/2011, on the basis of

European Assessment Document
EAD 350454-00-1104 "Fire stopping and fire sealing products – Penetration seals"

This European Technical Assessment is not to be transferred to manufacturers or agents of manufacturer other than those indicated on page 1, or manufacturing plants other than those laid down in the context of this European Technical Assessment.

Translations of this European Technical Assessment in other languages shall fully correspond to the original issued document and should be identified as such.

Communication of this European Technical Assessment, including transmission by electronic means, shall be in full. However, partial reproduction can be made with the written consent of the Österreichisches Institut für Bautechnik. In this case, partial reproduction has to be designated as such.

This European Technical Assessment may be withdrawn by the Österreichisches Institut für Bautechnik, in particular pursuant to information by the Commission according to Article 25 (3) of Regulation (EU) No 305/2011.

electronic copy
electronic copy
electronic copy
electronic copy
electronic copy
electronic copy
electronic copy

Specific parts

1 Technical description of the product

Hilti Firestop Cushion CFS-CU is a ‘Pillow/Cushion’ used in combination with further Hilti Firestop Cushion CFS-CU to form a penetration seal to reinstate the fire resistance performance of wall and floor constructions, where they have been provided with apertures for the penetration of services. The Hilti Firestop Cushion CFS-CU is available in three sizes referenced Hilti Firestop Cushion CFS-CU S, Hilti Firestop Cushion CFS-CU M and Hilti Firestop Cushion CFS-CU L.

Hilti Firestop Cushion CFS-CU is a service penetration seal to reinstate the fire resistance performance of wall and floor constructions, where they have been provided with apertures for the penetration of services, constructed from groups of Hilti Firestop Cushions CFS-CU.

Hilti Firestop Acrylic Sealant CFS-S ACR may be used together with Hilti Firestop Cushions CFS-CU (reaction to fire class D-s1 d0 according to EN 13501-1). For a detailed product information see ETA-10/0389.

2 Specification of the intended use(s) in accordance with the applicable European Assessment Document (hereinafter EAD)

2.1 Intended use

The intended use of Hilti Firestop Cushion CFS-CU is to temporarily or permanently reinstate the fire resistance performance of flexible wall constructions, rigid wall constructions and rigid floor constructions where they are penetrated by various services.

The specific elements of construction that the Hilti Firestop Cushion CFS-CU may be used to provide a penetration seal in, are as follows:

Construction-element	Construction
1. Rigid walls	The wall must have a minimum thickness of 100 mm and comprise concrete or masonry, with a minimum density of 650 kg/m ³ .
2. Rigid floors	The floor must have a minimum thickness of 150 mm and comprise concrete with a minimum density of 2200 kg/m ³ .
3. Flexible walls	The wall must have a minimum thickness of 100 mm and comprise timber or steel studs lined on both faces with minimum 2 layers of 12,5 mm thick boards. The aperture within the wall shall be lined with studs and 12,5 mm board (of the same type as the facings). A 12,5 mm thick Gypsum support board (E1), 200 mm long shall be fixed within this lining. For timber stud walls there must be a minimum distance of 100 mm of the seal to any stud and the cavity between stud and seal must be closed and minimum 100 mm insulation of Class A1 or A2 in the cavity between stud and seal.

The supporting construction must be classified in accordance with EN 13501-2 for the required fire resistance period.

“Hilti Firestop Cushion CFS-CU” may be used to provide a penetration seal with the following specific services –single, multiple or in combination:

- Cables/Cable trays/Conduits: Services as given in Annex C
- Plastic pipes: Services as given in Annex C

Cable trays/ladders and pipes shall be supported at most 250 mm and 500 mm away from the surface of the seal and all cables shall be supported by trays or ladders.

2.2 Use conditions

“Hilti Firestop Cushion CFS-CU” is intended for use in internal conditions with humidity lower than 85 % RH excluding temperatures below 0° C, without exposure to rain or UV, and can therefore - according to EAD 350454-00-1104, clause 1.2.1 - be categorized as Type Z₂.

2.3 Working life

The provisions made in this European Technical Assessment are based on an assumed working life of “Hilti Firestop Cushion CFS-CU” of 10 years, provided the conditions laid down in the technical literature of the manufacturer relating to packaging, transport, storage, installation, use and repair are met.

The indications given on the intended working life cannot be interpreted as a guarantee given by the producer or the Technical Assessment Body, but are to be regarded only as a means for selecting the appropriate product in relation to the expected economically reasonable working life of the works.

The real working life might be, in normal use conditions, considerably longer without major degradation affecting the Basic requirements for construction works.

2.4 Manufacturing

The European Technical Assessment is issued for the product on the basis of agreed data/information, deposited with the Österreichisches Institut für Bautechnik, which identifies the product that has been assessed and judged. Changes to the product or production process, which could result in this deposited data/information being incorrect, should be notified to the Österreichisches Institut für Bautechnik before the changes are introduced.

The Österreichisches Institut für Bautechnik will decide whether or not such changes affect the European Technical Assessment and consequently the validity of the CE marking on the basis of the European Technical Assessment and if so whether further assessment or alterations to the European Technical Assessment, shall be necessary.

3 Performance of the product and references to the methods used for its assessment

Basic requirements for construction works	Essential characteristic	Method of verification	Performance
BWR 2	Reaction to fire	EN 13501-1:2007	Clause 3.1.1 of the ETA
	Resistance to fire	EN 13501-2:2007	Clause 3.1.2 of the ETA
BWR 3	Air permeability	No performance assessed	
	Water permeability	No performance assessed	
	Content, emission and/or release of dangerous substances	No performance assessed	
BWR 4	Mechanical resistance and stability	No performance assessed	
	Resistance to impact / movement	EOTA TR 001:2003	Clause 3.3.2 of the ETA
	Adhesion	No performance assessed	
	Durability	EOTA TR 024:2006	Clause 3.3.4 of the ETA
BWR 5	Airborne sound insulation	No performance assessed	
BWR 6	Thermal properties	No performance assessed	
	Water vapour permeability	No performance assessed	

3.1 Safety in case of fire (BWR 2)

3.1.1 Reaction to fire

“Hilti Firestop Cushion CFS-CU” is classified ‘B-s1, d0’ in accordance with EN 13501-1.

3.1.2 Resistance to fire

“Hilti Firestop Cushion CFS-CU” has been tested in accordance with prEN 1366-3, installed within apertures in flexible walls (drywalls), rigid walls (masonry) and concrete floors.

The classification of the resistance to fire performance has been carried out in accordance with clause 7.5.8 in EN 13501-2:2007. Penetration seals made from Hilti Firestop Cushion CFS-CU with additional materials and services are classified according to combinations of performance parameters and classes as shown in Annex C. The classifications are valid for services running through openings of maximum dimensions $w \times h = 1200 \text{ mm} \times 1500 \text{ mm}$, in flexible and rigid walls with minimum thickness $t_E = 100\text{mm}$ and concrete floors up to 700 mm wide (length may be unlimited subject to a minimum length to seal area ratio of 4,86:1 m/m²) with minimum thickness of 150 mm.

The classifications are not valid for sandwich panel constructions.

An aperture framing made from gypsum board must be fixed inside openings in flexible wall constructions. The frame must be made of gypsum boards 12,5 mm thick on each side of the opening fixed by minimum 2 metal screws per side.

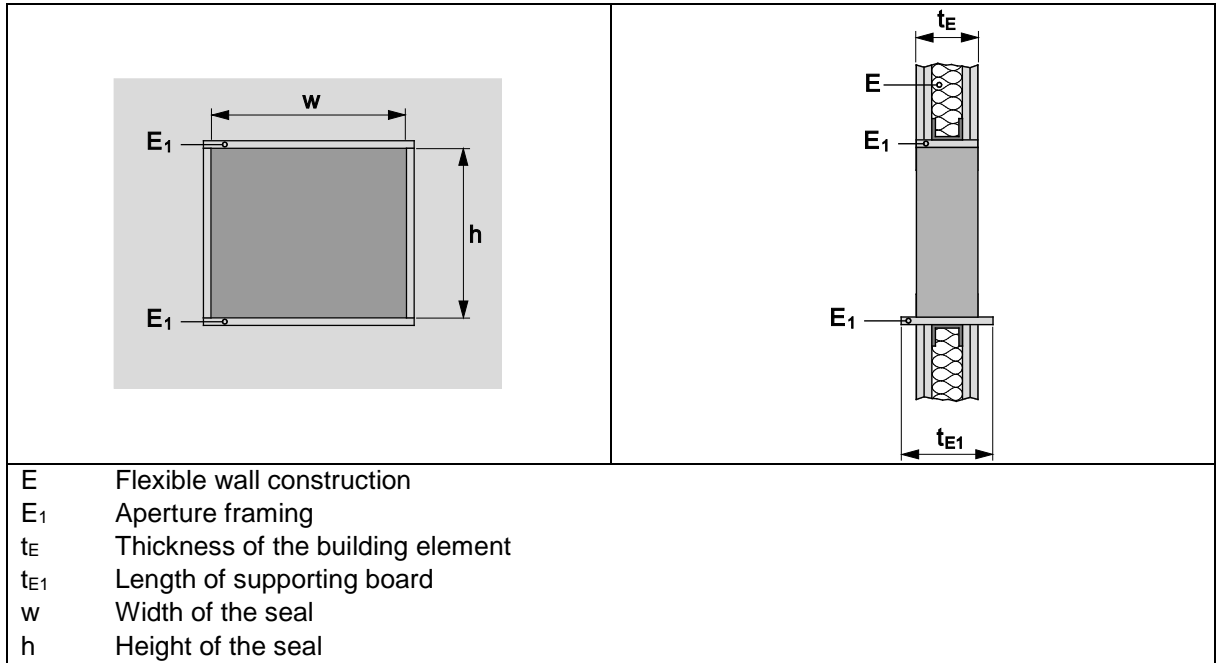

It is assumed that compressed air systems are switched off by other means in the case of fire.

The function of the pipe seal in case of pneumatic dispatch systems, pressurised air systems etc. is guaranteed only when the systems are shut off in case of fire.

The assessment does not cover the avoidance of destruction of the seal or of the abutting building element(s) by forces caused by temperature changes in case of fire. This has to be considered when designing the piping system.

This European Technical Assessment does not address any risks associated with leakage of dangerous liquids or gases caused by failure of the pipe(s) in case of fire.

The classifications relate to C/U (capped inside the furnace/uncapped outside) for metal pipes and U/C (capped outside/uncapped inside the furnace) for plastic and composite pipes. For further information refer to national regulations.

The durability assessment does not take account of the possible effect of substances permeating through the pipe on the penetration seal.

3.2 Hygiene, health and the environment (BWR 3)

3.2.1 Air permeability

No performance assessed.

3.2.2 Water permeability

No performance assessed.

3.2.3 Content, emission and/or release of dangerous substances

No performance assessed.

3.3 Safety and accessibility in use (BWR 4)

3.3.1 Mechanical resistance and stability

No performance assessed.

3.3.2 Resistance to impact/movement

Hilti Firestop Cushion CFS-CU have been tested in accordance with EOTA Technical Report - TR001 – Edition February 2003 at dimensions of 1500 mm x 1200 mm and without penetrating services.

The results demonstrate suitability for the following foreseen applications in accordance with EOTA Technical Report - TR001: A.1:

- Zones accessible primarily to those with high incentive to exercise care. Small risk of accidents occurring and of misuse.
- Zones accessible primarily to those with some incentive to exercise care. Some risk of accidents occurring and of misuse.
- Zones readily accessible to public and others with little incentive to exercise care. Risk of accidents occurring and of misuse.

3.3.3 Adhesion

No performance assessed.

3.3.4 Durability

“Hilti Firestop Cushion CFS-CU” has been tested in accordance with EOTA Technical Report TR024 for the intended use condition.

“Hilti Firestop Cushion CFS-CU” is therefore appropriate for use in internal conditions with humidity lower than 85 % RH excluding temperatures below 0° C, without exposure to rain or UV, and can therefore - according to EAD 350454-00-1104, clause 1.2.1 - be categorized as Type Z₂.

3.4 Protection against noise (BWR 5)

3.4.1 Airborne sound insulation

No performance assessed

3.5 Energy economy and heat retention (BWR 6)

3.5.1 Thermal properties

No performance assessed

3.5.2 Water vapour permeability

No performance assessed.

4 Assessment and verification of constancy of performance (hereinafter AVCP) system applied, with reference to its legal base

According to the Decision 1999/454/EC¹, amended by Decision 2001/596/EC² of the European Commission the system(s) of assessment and verification of constancy of performance (see Annex V of Regulation (EU) No 305/2011) is given in the following table.

Product(s)	Intended use(s)	Level(s) or class(es) (resistance to fire)	System of assessment and verification of constancy of performance
Fire Stopping and Fire Sealing Products	for fire compartmentation and/or fire protection or fire performance	any	1

In addition, according to the Decision 1999/454/EC, amended by Decision 2001/596/EC of the European Commission the system(s) of assessment and verification of constancy of performance, with regard to reaction to fire, is given the following table.

Product(s)	Intended use(s)	Level(s) or class(es) (reaction to fire)	System of assessment and verification of constancy of performance
Fire Stopping and Fire Sealing Products	For uses subject to regulations on reaction to fire	A1*, A2*, B*, C*	1
		A1**, A2**, B**, C**, D, E	3
		(A1 to E)***, F	4
<p>* Products/materials for which a clearly identifiable stage in the production process results in an improvement of the reaction to fire classification (e.g. an addition of fire retardants or a limiting of organic material)</p> <p>** Products/materials not covered by footnote (*)</p> <p>*** Products/materials that do not require to be tested for reaction to fire (e.g. products/materials of class A1 according to Commission Decision 96/603/EC, as amended)</p>			

¹ Official Journal of the European Communities no. L 178, 14.7.1999, p. 52

² Official Journal of the European Communities no. L 209, 2.8.2001, p. 33

electronic copy

5 Technical details necessary for the implementation of the AVCP system, as provided for in the applicable EAD

Technical details necessary for the implementation of the AVCP system are laid down in the control plan deposited with the Technical Assessment Body Österreichisches Institut für Bautechnik.

The notified product certification body shall visit the factory at least twice a year for surveillance of the manufacturer.

Issued in Vienna on 28.12.2020
by Österreichisches Institut für Bautechnik

The original document is signed by:

Rainer Mikulits
Managing Director

electronic copy
electronic copy
electronic copy
electronic copy
electronic copy
electronic copy
electronic copy

ANNEX A REFERENCE DOCUMENTS

A.1 References to standards mentioned in the ETA

EN 13501-1	Fire classification of construction products and building elements – Part 1: Classification using test data from reaction to fire tests
EN 13501-2	Fire classification of construction products and building elements – Part 2: Classification using test data from fire resistance tests
EN 1366-3	Fire resistance tests for service installations - Part 3: Penetration seals

A.2 Other reference documents



EOTA TR 001	Determination of impact resistance of panels and panel assemblies (2003?)
EOTA TR 024	Characterisation, Aspects of Durability and Factory Production Control for Reactive Materials, Components and Products
EAD 350454-00-1104	Fire stopping and fire sealing products: Penetration Seals

ANNEX B

DESCRIPTION OF THE PRODUCT “HILTI FIRESTOP CUSHION CFS-CU”:

Hilti Firestop Cushion CFS-CU is a ready-to-use Firestop Cushion made of an intumescent material contained in a fibre glass bag.

A detailed specification of the product is contained in document “Identification / Product Specification and Control Plan relating to the European Technical Assessment ETA-20/0991 of “Hilti Firestop Cushion CFS-CU” which is a non-public part of this ETA.

<ul style="list-style-type: none"> • Hilti Firestop Cushion CFS-CU S (small): (300mm x 40mm x 30mm) 	
<ul style="list-style-type: none"> • Hilti Firestop Cushion CFS-CU M (medium): (300mm x 80mm x 30mm) 	
<ul style="list-style-type: none"> • Hilti Firestop Cushion CFS-CU L (large): (300mm x 170mm x 30mm) 	

electronic copy electronic copy electronic copy electronic copy electronic copy electronic copy electronic copy

B.1 Installation

Installation of “Hilti Firestop Cushion CFS-CU” shall be conducted as follows:

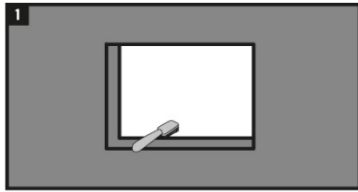

Clean the opening.

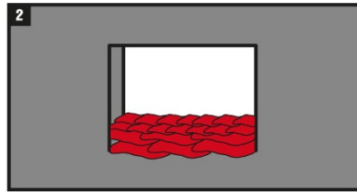

Cushion arrangement without cables running through wall partition. Opening must be framed in drywall applications.

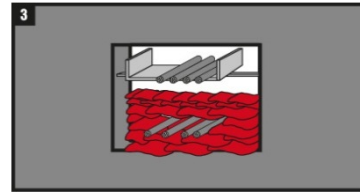

Cushion arrangement with cables/cable trays running through wall partition.

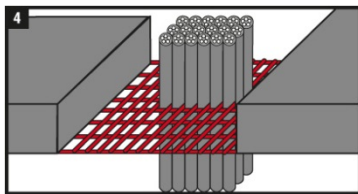

When closing floor openings, fasten wire mesh in place as shown in drawing.

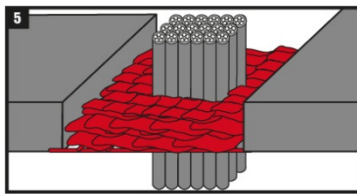

Cushion arrangement in floor. If required, seal gaps between cables and Hilti Firestop Cushions with Hilti Acrylic Sealant CFS-S ACR (please refer to Annex C).

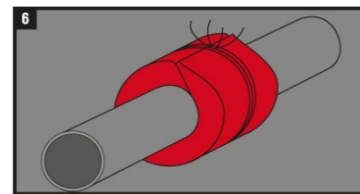

If required, wrap cable/cable tray resp. pipe with Hilti Firestop Cushion CFS-CU L and fix with wire as shown in drawing (please refer to Annex C).

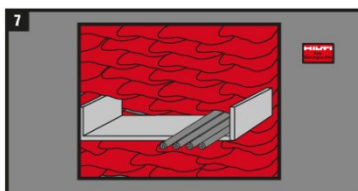

Fasten identification plate in place if required.

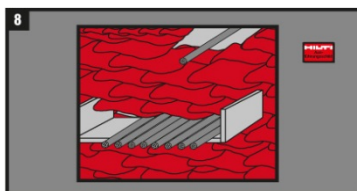

Re-installing cables: Remove a Hilti Firestop Cushion from the seal and install the cable or pipe. Close the opening with Hilti Firestop Cushions.

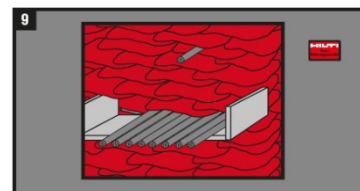

B.2 Use, maintenance, repair

“Hilti Firestop Cushion CFS-CU” should be installed and used as described earlier in this document.

“Hilti Firestop Cushion CFS-CU” seals which are damaged should not be used or if damaged after installation, should be removed and replaced with undamaged cushions.

In the area covered by the ETA when the set up recommendation have been followed there is no maintenance protocol to be followed.

ANNEX C

**RESISTANCE TO FIRE CLASSIFICATION OF PENETRATION SEALS MADE OF
“HILTI FIRESTOP CUSHION CFS-CU”**
**C.1 Flexible wall constructions and rigid wall constructions according to clause 2.1 of the ETA
with wall thickness t_E of minimum 100 mm**

Penetration seal / Services	Classification	
		with additional cable wrapping Additional Hilti Firestop cushion wrapped around cables for an extension of the seal depth by 150 mm on both sides of the seal
All sheathed cable types currently and commonly used in building practice in Europe (e.g. power, control, signal, telecommunication, data, optical fibre cables up to 80 mm diameter)	EI 45 / E 120	EI 120
Tied bundles of up to 80 mm overall diameter containing up to 21 mm diameter sheathed electrical/telecommunication/optical fibre cables	EI 45 / E 120	EI 120
All non-sheathed electrical cables up to 24 mm diameter	EI 45 / E 120	EI 120
All steel or plastic conduits up to 16 mm diameter	EI 45 / E 120 U/U	EI 120 U/U
PVC-U pipes according to EN 1452-1 and DIN 8061/8062 arranged linear, diameter Ø50 mm with wall thickness between 1,8 mm and 5,3 mm.	EI 120 U/C	---

C.2 Rigid wall constructions according to clause 2.1 of the ETA with wall thickness t_E of minimum 150 mm

Penetration seal / Services	Classification	
		with additional cable wrapping Additional Hilti Firestop cushion wrapped around cables for an extension of the seal depth by 150 mm on both sides of the seal
All sheathed cable types currently and commonly used in building practice in Europe (e.g. power, control, signal, telecommunication, data, optical fibre cables up to 80 mm diameter)	EI 60 / E 240	EI 120 / E 240
Bundles of up to 80 mm overall diameter containing up to 21 mm diameter sheathed electrical/telecommunication/optical fibre cables	EI 60 / E 240	EI 120 / E 240
All non-sheathed electrical cables up to 24 mm diameter	EI 60 / E 240	EI 120 / E 240
All steel or plastic conduits up to 16 mm diameter	EI 45 / E 240 U/U	EI 120 / E 240 U/U
PVC-U pipes according to EN 1452-1 and DIN 8061/8062 arranged linear, diameter Ø50 mm with wall thickness between 1,8 mm and 5,3 mm.	EI 240 U/C	---

Construction details:

Cable support construction: Perforated metal cable trays with a melting point higher than 1100°C (e.g. galvanised steel, stainless steel). Trays with organic coatings are covered if their overall classification is minimum A2 according to EN 13501-1.

Minimum distance (mm):			
Cables/cable tray to seal edge (s_1):	40	Cable to seal edge (s_1):	40
Cables to cable tray (s_2):	80	Cable to cable (s_2):	0
Plastic pipe to seal edge (s_1):	100	Cable to cable bundle (s_2):	80
Plastic pipe to plastic pipe (s_2):	100		
Plastic pipe to cable tray (s_2):	175		

Cables/conduits on cable trays:

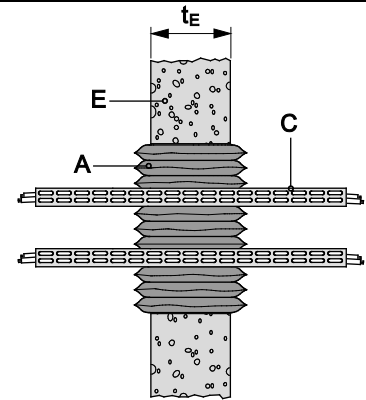
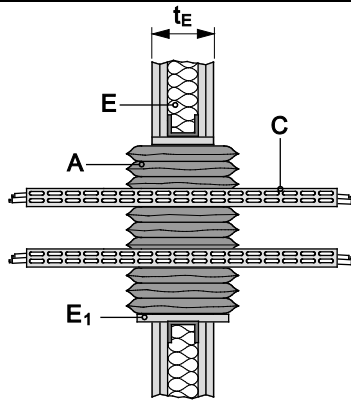
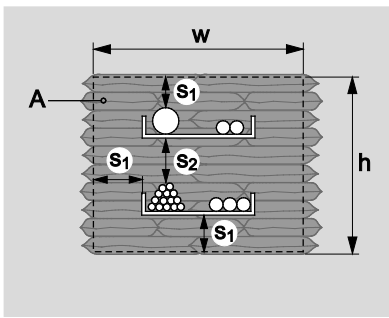

Cables/cable bundles/conduits without cable tray:

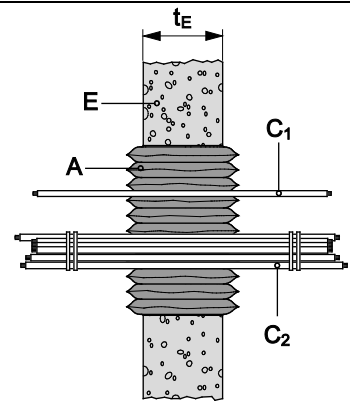
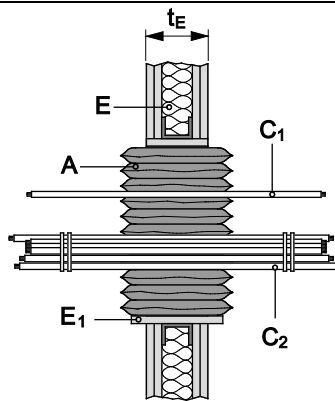
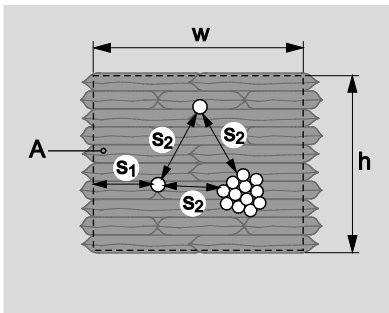

C.3 Rigid floor constructions according to clause 2.1 of the ETA with floor thickness t_E of minimum 150 mm

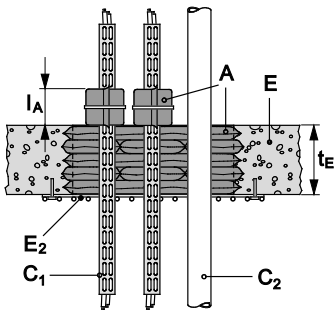
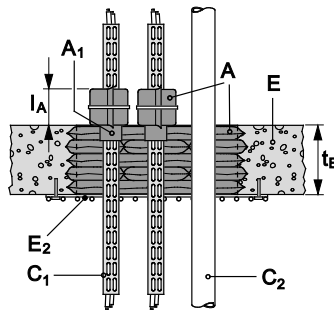
Penetration seal / Services	Classification	
	with additional cable wrapping ($l_A = 150\text{mm}$)	with additional cable wrapping ($l_A = 150\text{mm}$) ¹⁾ ($l_A = 300\text{mm}$) + Hilti Firestop Acrylic Sealant CFS-S ACR (A₁)
		
All sheathed cable types currently and commonly used in building practice in Europe (e.g. power, control, signal, telecommunication, data, optical fibre cables with a diameter of:		
Maximum \varnothing 21 mm	EI 120	EI 120
$21 \leq \varnothing \leq 90$ mm	EI 60 / E 120	EI 90 EI 120 ¹⁾
Bundles of up to 80 mm overall diameter containing up to 21 mm diameter sheathed electrical/ telecommunication/optical fibre cables	EI 60 / E 120	EI 90 / E 120
All non-sheathed electrical cables up to 24 mm diameter	EI 60 / E 120	EI 120 / E 240
All steel or plastic conduits up to 16 mm diameter	EI 60 / E 120 U/U	EI 120 / E 240 U/U
PVC-U pipes (C) according to EN 1452-1 and DIN 8061/8062 arranged linear, diameter \varnothing 50 mm with wall thickness between 1,8 mm and 5,3 mm.	EI 120 U/C	---

Construction detail:

Cable support construction: Perforated metal cable trays with a melting point higher than 1100°C (e.g. galvanised steel, stainless steel). Trays with organic coatings are covered if their overall classification is minimum A2 according to EN 13501-1.

Minimum distance (mm):			
Cables/cable tray to seal edge (s_1):	40	Cable to seal edge (s_1):	40
Cables to cable tray (s_2):	80	Cable to cable (s_2):	0
Plastic pipe to seal edge (s_1):	40	Cable to cable bundle (s_2):	80
Plastic pipe to plastic pipe: (s_2):	100		
Plastic pipe to cable tray (s_2):	50		

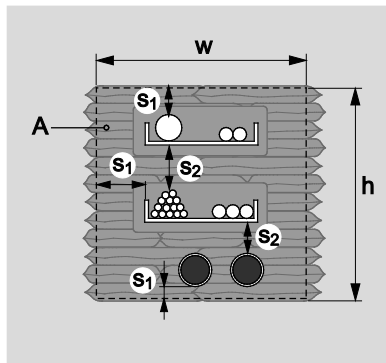

For explanation of abbreviations see the related text and Annex D

electronic copy

ANNEX D
ABBREVIATIONS USED IN DRAWINGS

Abbreviation	Description
A, A ₁ , A ₂ ,...	Firestop product
C, C ₁ , C ₂	Penetration Service
E	Building element (wall, floor)
E ₁	Supporting board
E ₂	Wire mesh
t _E	Thickness of building element (wall, floor)
t _{E1}	Length of supporting board
w	width
h	height
l _A	length Firestop product (additional)