



BX 3  
BX 3-L

English



# 1 Information about the documentation

## 1.1 About this documentation

- Read this documentation before initial operation or use. This is a prerequisite for safe, trouble-free handling and use of the product.
- Observe the safety instructions and warnings in this documentation and on the product.
- Always keep the operating instructions with the product and make sure that the operating instructions are with the product when it is given to other persons.

## 1.2 Explanation of symbols used

### 1.2.1 Warnings

Warnings alert persons to hazards that occur when handling or using the product. The following signal words are used:



**DANGER !**

- ▶ Draws attention to imminent danger that will lead to serious personal injury or fatality.



**WARNING !**

- ▶ Draws attention to a potential threat of danger that can lead to serious injury or fatality.







**CAUTION !**

- ▶ Draws attention to a potentially dangerous situation that could lead to slight personal injury or damage to the equipment or other property.





### 1.2.2 Symbols in the documentation

The following symbols are used in this document:

|   |   |
|---|---|
|    | Read the operating instructions before use.                           |
|    | Instructions for use and other useful information                     |
|    | Dealing with recyclable materials                                     |
|  | Do not dispose of electric equipment and batteries as household waste |

### 1.2.3 Symbols in the illustrations

The following symbols are used in illustrations:

|   |   |
|---|---|
|  | These numbers refer to the corresponding illustrations found at the beginning of these operating instructions                             |
|  | The numbering reflects the sequence of operations shown in the illustrations and may deviate from the steps described in the text         |
|  | Item reference numbers are used in the <b>overview illustrations</b> and refer to the numbers used in the <b>product overview section</b> |
|  | This symbol is intended to draw special attention to certain points when handling the product.  |
|  | Wireless data transfer  |

### 1.3 Product-dependent symbols

#### 1.3.1 Symbols on the product

The following symbols are used on the product:

|  |                        |
|--|------------------------|
|  | General mandatory sign |
|  | Wear eye protection    |
|  | Wear ear protection    |
|  | Wear a hard hat        |
|  | Direct current (DC)    |

### 1.4 Product information

products are designed for professional users and only trained, authorized personnel are permitted to operate, service and maintain the products. This personnel must be specifically informed about the possible hazards. The product and its ancillary equipment can present hazards if used incorrectly by untrained personnel or if used not in accordance with the intended use.

The type designation and serial number are printed on the rating plate.

- ▶ Write down the serial number in the table below. You will be required to state the product details when contacting Hilti Service or your local Hilti organization to inquire about the product.

#### Product information

|                |               |
|----------------|---------------|
| Fastening tool | BX 3   BX 3-L |
| Generation     | 02            |
| Serial no.     |               |

### 1.5 Declaration of conformity

We declare, on our sole responsibility, that the product described here complies with the applicable directives and standards. A copy of the declaration of conformity can be found at the end of this documentation.

The technical documentation is filed here:

Hilti Entwicklungsgesellschaft mbH | Tool Certification | Hiltistrasse 6 | 86916 Kaufering, Germany

## 2 Safety

### 2.1 General power tool safety warnings

**WARNING**

**Read all safety warnings and all instructions.** Failure to follow the warnings and instructions may result in electric shock, fire and/or serious injury.

**Save all warnings and instructions for future reference.**

#### Work area safety

- ▶ **Keep work area clean and well lit.** Cluttered or dark areas invite accidents.
- ▶ **Do not operate power tools in explosive atmospheres, such as in the presence of flammable liquids, gases or dust.** Power tools create sparks which may ignite the dust or fumes.
- ▶ **Keep children and bystanders away while operating a power tool.** Distractions can cause you to lose control.

#### Electrical safety

- ▶ **Avoid body contact with earthed or grounded surfaces, such as pipes, radiators, ranges and refrigerators.** There is an increased risk of electric shock if your body is earthed or grounded.
- ▶ **Do not expose power tools to rain or wet conditions.** Water entering a power tool will increase the risk of electric shock.

#### Personal safety

- ▶ **Stay alert, watch what you are doing and use common sense when operating a power tool. Do not use a power tool while you are tired or under the influence of drugs, alcohol or medication.** A moment of inattention while operating power tools may result in serious personal injury.

- ▶ **Use personal protective equipment. Always wear eye protection.** Protective equipment such as dust mask, non-skid safety shoes, hard hat, or hearing protection used for appropriate conditions will reduce personal injuries.
- ▶ **Prevent unintentional starting. Ensure the switch is in the off-position before connecting to battery pack, picking up or carrying the tool.** Carrying power tools with your finger on the switch or energising power tools that have the switch on invites accidents.
- ▶ **Remove any adjusting key or wrench before turning the power tool on.** A wrench or a key left attached to a rotating part of the power tool may result in personal injury.
- ▶ **Do not overreach. Keep proper footing and balance at all times.** This enables better control of the power tool in unexpected situations.
- ▶ **Dress properly. Do not wear loose clothing or jewellery. Keep your hair, clothing and gloves away from moving parts.** Loose clothes, jewellery or long hair can be caught in moving parts.
- ▶ **If devices are provided for the connection of dust extraction and collection facilities, ensure these are connected and properly used.** Use of dust collection can reduce dust-related hazards.

#### Power tool use and care

- ▶ **Do not force the power tool. Use the correct power tool for your application.** The correct power tool will do the job better and safer at the rate for which it was designed.
- ▶ **Do not use the power tool if the switch does not turn it on and off.** Any power tool that cannot be controlled with the switch is dangerous and must be repaired.
- ▶ **Disconnect the battery pack from the power tool before making any adjustments, changing accessories, or storing power tools.** Such preventive safety measures reduce the risk of starting the power tool accidentally.
- ▶ **Store idle power tools out of the reach of children and do not allow persons unfamiliar with the power tool or these instructions to operate the power tool.** Power tools are dangerous in the hands of untrained users.
- ▶ **Maintain power tools. Check for misalignment or binding of moving parts, breakage of parts and any other condition that may affect the power tool's operation. If damaged, have the power tool repaired before use.** Many accidents are caused by poorly maintained power tools.
- ▶ **Keep cutting tools sharp and clean.** Properly maintained cutting tools with sharp cutting edges are less likely to bind and are easier to control.
- ▶ **Use the power tool, accessories and tool bits etc. in accordance with these instructions, taking into account the working conditions and the work to be performed.** Use of the power tool for operations different from those intended could result in a hazardous situation.

#### Battery tool use and care

- ▶ **Recharge only with the charger specified by the manufacturer.** A charger that is suitable for one type of battery pack may create a risk of fire when used with another battery pack.
- ▶ **Use power tools only with specifically designated battery packs.** Use of any other battery packs may create a risk of injury and fire.
- ▶ **When battery pack is not in use, keep it away from other metal objects, like paper clips, coins, keys, nails, screws or other small metal objects, that can make a connection from one terminal to another.** Shorting the battery terminals together may cause burns or a fire.
- ▶ **Under abusive conditions, liquid may be ejected from the battery; avoid contact. If contact accidentally occurs, flush with water. If liquid contacts eyes, additionally seek medical help.** Liquid ejected from the battery may cause irritation or burns.

#### Service

- ▶ **Have your power tool serviced by a qualified repair person using only identical replacement parts.** This will ensure that the safety of the power tool is maintained.

## 2.2 Tacker safety warnings

- ▶ **Always assume that the tool contains fasteners.** Careless handling of the fastening tool can result in unexpected firing of nails causing personal injury.
- ▶ **Do not point the tool towards yourself or anyone nearby.** A nail will be ejected by the tool if it is triggered unexpectedly, possibly leading to injury.
- ▶ **Do not actuate the tool unless the tool is placed firmly against the workpiece.** If the tool is not in contact with the workpiece, the fastener may be deflected away from your target.
- ▶ **Disconnect the tool from the power source when the fastener jams in the tool.** While removing a jammed fastener, the fastening tool may be accidentally activated if it is plugged in.
- ▶ **Use caution while removing a jammed fastener.** The mechanism may be under tension and the nail may be forcefully ejected while attempting to free a jam.

- ▶ **When fastening electrical cables, make sure the cables are not energized. Hold the fastening tool only by insulated gripping surfaces. Use only fasteners designed for electrical cable installations. Check that the fastener has not damaged the insulation of the electrical cable.** A nail that damages the insulation of electric cables can lead to electric shock and fire hazards.

## 2.3 Safety instructions

### Basic information concerning safety

**⚠ WARNING! Read all safety precautions and other instructions.** Failure to observe the safety precautions and other instructions may result in electric shock, fire and/or serious injury.

Keep all safety precautions and instructions for future reference.

### Requirements to be met by users

- ▶ Only authorized, appropriately trained persons may operate or service this tool.

### Personal protective equipment

- ▶ You and any other persons in the vicinity must wear suitable eye protection and a hard hat while the tool is in use.
- ▶ Wear ear protectors.
  - ◀ Exposure to noise can cause hearing loss.

### Personal safety

- ▶ Observe the information printed in the operating instructions concerning operation, care and maintenance.
- ▶ Stay alert, watch what you are doing and use common sense when operating a direct fastening tool. Don't use the tool when you are tired or under the influence of drugs, alcohol or medication. Take a break if you experience pain or feel unwell. A moment of inattention while operating tools may result in serious personal injury.
- ▶ Avoid working in awkward body positions. Make sure you work from a safe stance and stay in balance at all times.
- ▶ Wear non-skid shoes.
- ▶ Never pull the fastener guide or fastener back with your hand.
  - ◀ Under certain circumstances, the tool could be made ready to fire by pulling the fastener guide or the fastener back by hand. When the tool is ready to fire, fasteners or the piston could be driven inadvertently into parts of the body.
- ▶ Keep the arms slightly bent while operating the tool (do not straighten the arms).
- ▶ Keep other people away from the working area, especially children.

### Use and care of direct fastening tools

**⚠ WARNING! Danger of fasteners penetrating right through.** Before driving fasteners, check to make sure that no one is present behind or below the object into which the fastener is to be driven.

- ▶ Before beginning the work, carry out a test by driving 2 fasteners into the material you are working on.
- ▶ Use the right tool for the work you are carrying out. Do not use the tool for purposes for which it was not intended. Use it only as directed and when in faultless condition.
- ▶ Never leave a loaded tool unattended.
- ▶ Transport and store the tool in a secured toolbox.
- ▶ Always unload the tool (remove fasteners) before cleaning, maintenance, changing the fastener guide, before work breaks and before storing the tool.
- ▶ When not in use, the tool should be unloaded and stored in a locked, dry place where it is inaccessible to children.
- ▶ Check the tool and the accessories for any damage. Check that moving parts function faultlessly, without sticking, and that no parts are damaged.
  - ◀ All parts must be fitted correctly and fulfill all conditions necessary for correct operation of the tool. Damaged parts must be properly repaired or replaced by **Hilti Service** unless otherwise stated in the operating instructions.
- ▶ Before driving fasteners, check that there is no electrical wiring behind the surface on which you are working.
- ▶ Do not attempt to drive fasteners into unsuitable materials.
  - ◀ Unsuitable materials include welded steel and cast steel, cast iron, glass, marble, plastic, bronze, brass, copper, insulating material, hollow brick, ceramic brick, thin sheet metal (< 4 mm) and cellular concrete. Driving a fastener into these materials may cause the fastener to break, shatter or to be driven right through.
- ▶ Pull the trigger only when the tool is fully pressed against the working surface at right angles.

- ▶ When driving fasteners, always hold the fastening tool at right angles to the working surface in order to prevent the fastener being deflected by the surface.
- ▶ Keep the grips dry, clean and free from oil and grease.
- ▶ Never drop the tool.
- ▶ Do not use the magazine as a grip.
- ▶ Do not use the tool in places where there is a risk of fire or explosion unless the tool is specially approved for this type of use.
- ▶ Never drive fasteners into existing holes unless this is recommended by **Hilti** (e.g. DX-Kwik).

### **Workstation**

- ▶ Keep the workplace tidy. Objects which could cause injury should be removed from the working area.
  - ◀ Untidiness in the working area can lead to accidents.
- ▶ Make sure that the working area is well lit and well ventilated.

### **Mechanical safety rules**

- ▶ Do not tamper with or modify the tool or parts of it, especially the piston.
- ▶ Use only fasteners of a type approved for use with the tool.

### **Thermal safety rules**

- ▶ Do not exceed the recommended maximum fastener driving rate.
- ▶ If the tool has overheated, allow it to cool down.
- ▶ Do not dismantle the tool while it is hot. Allow the tool to cool down.

## **2.4 Battery use and care**

- ▶ Observe the special regulations and instructions applicable to the transport, storage and use of Li-ion batteries.
- ▶ Do not expose batteries to high temperatures, direct sunlight or fire.
- ▶ Do not disassemble, crush or incinerate batteries and do not subject them to temperatures over 80 °C.
- ▶ Do not use or charge batteries that have suffered mechanical impact, have been dropped from a height or show signs of damage. In this case, always contact your **Hilti Service**.
- ▶ If the battery is too hot to touch it may be defective. In this case, place the product in a non-flammable location, well away from flammable materials, where it can be kept under observation and allowed to cool down. In this case, always contact your **Hilti Service**.

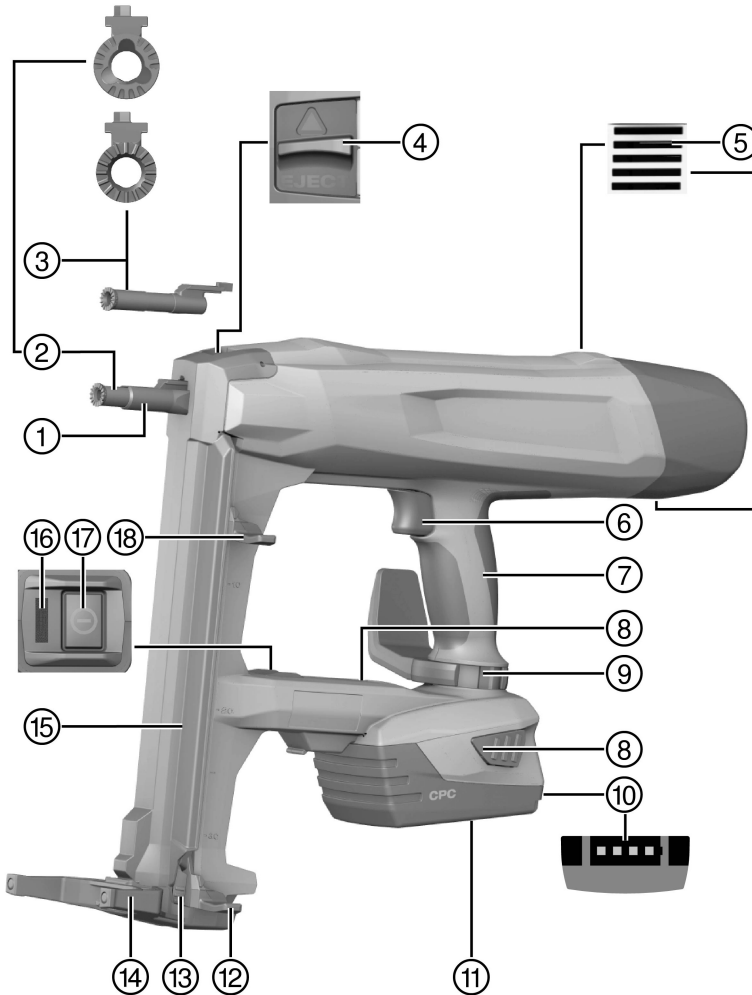
**3 Description****3.1 Overview of the product**



- |                                    |                                  |
|------------------------------------|----------------------------------|
| ① Nosepiece                        | ⑩ State of charge display        |
| ② Fastener guide X-FG B3-ME 02     | ⑪ Li-ion battery                 |
| ③ Fastener guide X-FG B3-IF 02     | ⑫ Nail pusher, locked position   |
| ④ Fastener guide locking mechanism | ⑬ Nail pusher release mechanism  |
| ⑤ Air vents                        | ⑭ Support leg                    |
| ⑥ Safety trigger                   | ⑮ Magazine                       |
| ⑦ Grip                             | ⑯ Status indicator               |
| ⑧ Release buttons                  | ⑰ On/off button                  |
| ⑨ Belt hook/scaffold hook          | ⑱ Nail pusher, unlocked position |

### 3.2 Intended use

The product is a hand-held, battery-operated fastening tool for indoor use. It is designed to drive specially-manufactured fasteners (nails) into concrete, steel, masonry, sand-lime block and other materials suitable for use of the direct fastening technique. The product is also designed to fasten electrical cables with clips if the appropriate fasteners are used. Use only approved fasteners in conjunction with the fastener guide designed for use with these specific fasteners (see “Technical data” section).

The fastening tool, battery and fasteners form a single technical unit. This means that trouble-free fastening can be ensured with this fastening tool only when it is used in conjunction with the **Hilti** fasteners specially designed and manufactured for it and with the batteries and chargers recommended by **Hilti**. The fastening and application recommendations made by **Hilti** apply only when this condition is observed.

- ▶ The fastening tool is for hand-held use only.
- ▶ Misuse of the fastening tool must be ruled out. Misuse of the tool is understood to include driving fasteners into very soft materials (e.g. wood) or into excessively hard materials (e.g. high-strength steel or very hard natural stone).
- ▶ Use only **Hilti** Li-ion batteries of the B 22 series with this product.
- ▶ Use only **Hilti** battery chargers of the C 4/36 series to charge these batteries.

### 3.3 Safety devices

When using the nail magazine, the nail detector prevents triggering without a nail loaded, which could damage the fastening tool.

The contact pressure safety device is intended to prevent the free flying of nails (i.e. actuation and driving a nail when the nosepiece is not in contact with the workpiece). When using a nail magazine, the fastening tool can be pressed against the surface and triggered only when a nail is loaded in the tool.

### 3.4 Features

The fastening tool is equipped with an ergonomic, non-slip and vibration-absorbing grip, a belt and scaffold hook and a support leg. The tool is protected from overloading by electronic overload protection and from overheating by temperature monitoring.

### 3.5 Bluetooth

The product has a Bluetooth interface. Wireless communication via Bluetooth is possible as soon as the battery has been fitted and the fastening tool switched on at the on/off button.

Data transfer continues for three hours after the tool has switched to standby mode or after the tool has been switched off at the on/off button.

To deactivate Bluetooth manually, press and hold down the on/off button for at least 5 seconds until the LED shows blue twice.

When the battery is removed, no further data are transferred.

Bluetooth is not available in all markets.

### 3.6 Status indicator

The status indicator provides information about the status of the fastening tool.

| Status | Meaning   |
|--------|---|
| Off    | <ul style="list-style-type: none"> <li>• The fastening tool is switched off.</li> </ul> |

| Status                                | Meaning   |
|---------------------------------------|---|
| The LED lights green.                 | <ul style="list-style-type: none"> <li>The fastening tool is switched on and ready for use.</li> </ul>  |
| The LED blinks green every 3 seconds. | <ul style="list-style-type: none"> <li>The fastening tool is in stand-by mode. Press the nose of the tool against the working surface to switch it on.</li> </ul> |
| The LED lights blue.                  | <ul style="list-style-type: none"> <li>The fastening tool is switched on, nail strips require to be loaded.</li> </ul>  |
| LED blinks blue.                      | <ul style="list-style-type: none"> <li>The fastening tool is switched on, the magazine is completely empty.</li> </ul>  |
| The LED blinks green.                 | <ul style="list-style-type: none"> <li>The fastening tool is too hot or the battery has insufficient power. Please refer to "Troubleshooting".</li> </ul>         |
| The LED blinks red.                   | <ul style="list-style-type: none"> <li>Malfunction – please refer to "Troubleshooting".</li> </ul>  |
| The LED lights red.                   | <ul style="list-style-type: none"> <li>Malfunction – please refer to "Troubleshooting".</li> </ul>  |

### 3.7 Indication of battery charge status

When one of the battery release buttons is pressed the display indicates the battery's state of charge.

 Reliable indication of the charge status is not possible while a fastener is being driven or immediately after a fastener is driven.

| Status                     | Meaning  |
|----------------------------|--|
| All four LEDs light green. | <ul style="list-style-type: none"> <li>Charge status is 75 % to 100 %.</li> </ul>                                  |
| Three LEDs light green.    | <ul style="list-style-type: none"> <li>Charge status is 50 % to 75 %.</li> </ul>                                   |
| Two LEDs light green.      | <ul style="list-style-type: none"> <li>Charge status is 25 % to 50 %.</li> </ul>                                   |
| One LED lights green.      | <ul style="list-style-type: none"> <li>Charge status is 10 % to 25 %.</li> </ul>                                   |
| One LED flashes green.     | <ul style="list-style-type: none"> <li>Charge status is below 10 %. The battery has insufficient power.</li> </ul> |

### 3.8 Items supplied

BX 3 or BX 3-L fastening tool, operating instructions.

You can find other system products approved for your product at your local **Hilti** Center or online at: [www.hilti.com](http://www.hilti.com)

## 4 Technical data

### 4.1 Fastening tool

|  |                      | BX 3            | BX 3-L            |
|--|----------------------|-----------------|-------------------|
| Weight in accordance with EPTA procedure 01/2003 | B 22/2.6 Li-Ion (02) | 4.0 kg          | 4.0 kg            |
|  | B 22/3.0 Li-Ion (01) | 4.1 kg          | 4.1 kg            |
|  | B 22/5.2 Li-Ion (01) | 4.3 kg          | 4.3 kg            |
| Nail length (collated nails)                     |                      | 14 mm ...30 mm  | 14 mm ...36 mm    |
| Accessibility                                    |                      | 52 mm           | 46 mm             |
| Nail diameter                                    |                      | 3 mm            | 2.75 mm ...3.0 mm |
| Magazine capacity                                |                      | 30 nails        | 30 nails          |
| Compression stroke                               |                      | 12 mm           |                   |
| Contact pressure                                 |                      | 50 N ...70 N    | 50 N ...70 N      |
| Application temperature (ambient temperature)    |                      | -15 °C ...50 °C | -15 °C ...50 °C   |
| Recommended maximum fastening rate               |                      | 650/h           | 650/h             |
| Rated voltage                                    |                      | 21.6 V          | 21.6 V            |

|   | <b>BX 3</b>              | <b>BX 3-L</b>            |
|---|--------------------------|--------------------------|
| <b>Maximum emitted transmission power</b> | -11.9 dBm                | -11.9 dBm                |
| <b>Frequency</b>                          | 2,400 MHz ...2,483.5 MHz | 2,400 MHz ...2,483.5 MHz |

#### 4.2 Noise information and vibration values in accordance with EN 60745

The sound pressure and vibration values given in these instructions have been measured in accordance with a standardized test and may be used to compare one power tool with another. They may be used for a preliminary assessment of exposure. The data given represents the main applications of the power tool. However, if the power tool is used for different applications, with different accessories or is poorly maintained, the data may vary. This may significantly increase exposure over the total working period. An accurate estimation of exposure should also take into account the times when the tool is switched off, or when it is running but not actually being used for a job. This may significantly reduce exposure over the total working period. Set out additional safety measures to protect the operator from the effects of noise and/or vibration, such as: Maintaining the power tool and accessories, keeping the hands warm, reorganization of work patterns.

##### Noise and vibration information

|  |                 |        |
|--|-----------------|--------|
| <b>Typical A-weighted emission sound power level (when driving nails) (<math>L_{WA}</math>)</b>    | <b>Concrete</b> | 101 dB |
|  | <b>Steel</b>    | 105 dB |
| <b>Typical A-weighted emission sound pressure level (when driving nails) (<math>L_{pA}</math>)</b> | <b>Concrete</b> | 90 dB  |
|  | <b>Steel</b>    | 94 dB  |
| <b>Uncertainty for the given sound level (K)</b>   |                 | 3 dB   |

##### Total uniaxial vibration values (in z-direction)

|   |                 |                      |
|---|-----------------|----------------------|
| <b>Vibration emission value (when driving nails) (<math>a_n</math>)</b> | <b>Concrete</b> | 2.3 m/s <sup>2</sup> |
|   | <b>Steel</b>    | 2.2 m/s <sup>2</sup> |
| <b>Uncertainty (K)</b>  |                 | 1.5 m/s <sup>2</sup> |

#### 4.3 Battery

|                                  |                  |
|----------------------------------|------------------|
| <b>Battery operating voltage</b> | 21.6 V           |
| <b>Ambient temperature</b>       | -17 °C ... 60 °C |
| <b>Storage temperature</b>       | -20 °C ... 40 °C |

## 5 Preparations at the workplace

### CAUTION

#### Risk of injury by inadvertent starting!

- ▶ Before inserting the battery, make sure that the product is switched off.
- ▶ Remove the battery before making any adjustments to the power tool or before changing accessories.

Observe the safety instructions and warnings in this documentation and on the product.

#### 5.1 Inserting the battery

In order to achieve maximum battery lifetime, replace the discharged battery with a fully charged battery as soon as you notice a clear drop in battery performance.



1. Check that the contacts on the battery and on the tool are free from foreign objects.
2. Fit the battery and make sure that it is heard to engage.
  - ◀ Once the battery has been fitted, the charge status LEDs light for a short time.

**⚠ CAUTION**

**A falling battery presents a hazard.** If the battery is not secured correctly it may drop out and fall while the work is in progress.

- ▶ Always check that the battery is securely seated.

3. Check that the battery is securely seated in the fastening tool.

## 5.2 Removing the battery

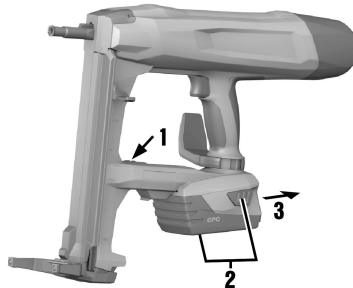

1. Switch the fastening tool off. → page 13
2. Press the two release buttons and hold them in the pressed position.
3. Pull the battery out of the power tool to the rear.

## 5.3 Removing the fastener guide

1. Switch the fastening tool off. → page 13
2. Remove the battery. → page 10
3. Pull the nail pusher down until it engages.
4. Unload the magazine. → page 14
5. Slide the fastener guide locking catch as far as it will go in the direction of the arrow.
  - ◀ The fastener guide will be released.
6. Remove the fastener guide.

## 5.4 Inserting the fastener guide

1. Switch the fastening tool off. → page 13

2. Remove the battery. → page 10
3. Pull the nail pusher down until it engages.
4. Unload the magazine. → page 14
5. Slide the fastener guide locking catch as far as it will go in the direction of the arrow and hold it in this position.
6. Slide the fastener guide into the nosepiece until it is heard to engage.
7. Release the fastener guide locking catch.
  - ◀ The fastener guide jumps to the middle position.
8. Grip and pull the fastener guide to check that it is securely seated.

## 5.5 Working safely with the belt and scaffold hook



- ▶ Before beginning work, make sure that the belt hook / scaffold hook is securely attached to the tool.
- ▶ Use the belt hook / scaffold hook only when necessary. Lay the tool down in a safe place when it is not in use for a long period.

## 5.6 Loading for magazine operation

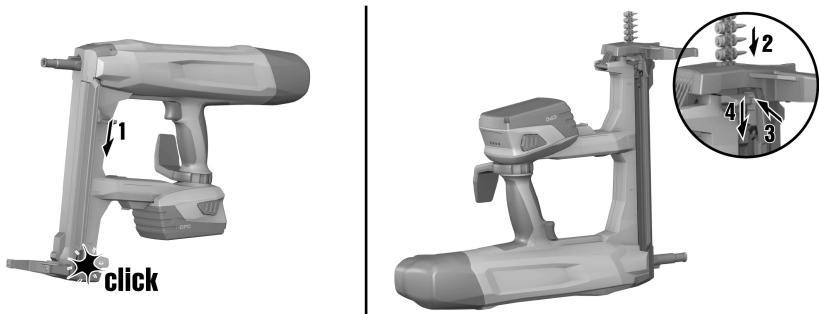

### WARNING

**Risk of crushing!** Allowing the nail pusher to snap back under spring pressure may result in finger injuries and cause damage to the fastening tool.

- ▶ When pulling the nail pusher down, take care to ensure that it engages securely. Do not allow the nail pusher to jump back under spring pressure.

1. Pull the nail pusher down until it engages.
2. Slide the nail strips into the magazine (a maximum of 3 strips of 10 nails).
3. Hold the nail pusher securely and press the nail pusher release button.
4. Guide the nail pusher back until it contacts a nail.

## 6 Types of work

### 6.1 Using the support leg

On an even working surface, the support leg makes it easier to hold the fastening tool perpendicular as attention then only has to be paid to lateral alignment. On uneven surfaces it may necessary to retract the support leg in order to ensure that the fastener guide is perpendicular to the working surface.

#### 6.1.1 Retracting the support leg



1. Push against the support leg to release it from its resting position.
2. Pivot the support leg back through about 230°.
3. Push against the support leg from below until it engages in the retracted position.

#### 6.1.2 Extending the support leg



### CAUTION

**Risk of pinching the fingers!** When folding the support leg back there is a risk of trapping and pinching the fingers between the support leg and the casing of the tool.

- ▶ Hold the fastening tool by the grip when extending/retracting the support leg.

1. Push against the support leg to release it from its resting position.
2. Pivot the support leg forward through about 230°.
3. Push against the support leg from below until it engages in the extended position.

## 6.2 Switching the fastening tool on/off

### 6.2.1 Switching the fastening tool on

#### WARNING

**Risk of injury!** Pressing the nosepiece of the fastening tool against a part of the body may lead to serious injury due to inadvertent firing and release of a fastener.

▶ **Never press the nosepiece of the tool against your hand or any other part of the body.**

- ▶ Press the on/off button.
  - ◀ The spring mechanism can be heard to build up tension and the status indicator lights green.



When battery performance drops, tensioning of the spring mechanism will take longer than with a fully charged battery.

Battery performance drops at low temperatures.

If you continue to operate the fastening tool after noticing a drop in battery performance, the fastening tool will switch itself off automatically before damage to the battery cells occurs.

### 6.2.2 Switching the fastening tool off

- ▶ Press the on/off button.
  - ◀ The spring mechanism can be heard to release the tension and the status indicator goes out.

## 6.3 Driving a nail

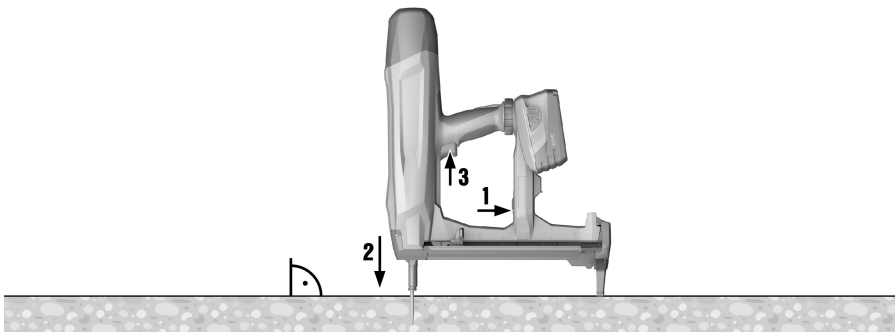

#### WARNING

**Risk of injury by flying parts!** When driving a fastener, there is a risk of injury to the body and eyes caused by splintered fragments of the workpiece and by flying parts of the nail strip.

▶ **Wear personal protective equipment and always wear protective glasses and protective gloves.** Other persons in the vicinity must also wear eye protection and a hard hat.

#### WARNING

**Risk of injury!** Pressing the nosepiece of the fastening tool against a part of the body may lead to serious injury due to inadvertent firing and release of a fastener.

▶ **Never press the nosepiece of the tool against your hand or any other part of the body.**

1. Switch the fastening tool on. → page 13
2. Position the nose of the fastening tool at right angles to the working surface and then press it against the surface, pushing the fastener guide in as far as it will go.
3. Drive the nail by pressing the safety trigger.

- Lift the fastening tool completely away from the working surface after driving a fastener.



The fastening tool switches itself off automatically if the fastener guide is pressed against the working surface for longer than 6 seconds without a nail being driven. The fastening tool can be switched on again by pressing the on/off button.



If the fastening tool is not used for 6 minutes, spring tension is relaxed and the fastening tool switches to stand-by mode automatically. The springs are automatically retensioned and the fastening tool becomes ready for use again as soon as it is pressed against the working surface. If the fastening tool is left in stand-by mode for longer than three hours it switches itself off automatically. The fastening tool can be switched back on again by pressing the on/off button.

#### 6.4 Switching off Bluetooth

- ▶ Press the on/off button for at least 5 seconds until the LED shows blue twice.
  - ◀ No further data transfer is possible.
  - ▼ Bluetooth is not available in all markets.



Bluetooth can be deactivated if you are in a sensitive environment (e.g. a hospital) where use of Bluetooth is prohibited.

#### 6.5 Removing a nail when in magazine mode

- Pull the nail pusher down until it engages.
- Slide the nail downwards out of the magazine.
- Hold the nail pusher securely and press the nail pusher release button.
- Guide the nail pusher back to its original position.

#### 6.6 Jammed nails

Individual nails may get stuck in the fastener guide. You can remove jammed nails from the fastener guide with the aid of the X-NP drift punch set. Accessories are available from your **Hilti** Center or can be ordered online at [www.hilti.com](http://www.hilti.com).



#### WARNING

**There is a risk of injury and damage to the fastening tool.** Use of unsuitable items instead of the recommended genuine **Hilti** accessories may result in injury or damage to the fastening tool.

- ▶ To release a jammed nail, use only the recommended drift punch set.



#### CAUTION

**Risk of injury by flying parts!** Triggering the tool (attempting to drive a fastener) when foreign objects are present in the area around the fastener guide, or when a fastener is jammed in the fastener guide, may lead to injury caused by flying objects or fragments.

- ▶ Never attempt to remedy tool malfunctions by continuing to trigger the tool.

##### 6.6.1 Releasing jammed nails

- Remove the fastener guide (see → page 10).
- Fit the fastener guide into the supporting sleeve from the drift punch set.
- Use the drift punch and a hammer to drive the jammed nail out of the fastener guide.
- Fit the fastener guide (see → page 10).

## 7 Care and maintenance

### 7.1 Care and maintenance of cordless tools



#### WARNING

**Risk of injury with battery inserted !**

- ▶ Always remove the battery before carrying out care and maintenance tasks!



### Care and maintenance of the tool

- Carefully remove stubborn dirt.
- Clean the air vents carefully with a dry brush.
- Use only a slightly damp cloth to clean the casing. Do not use cleaning agents containing silicone as these can attack the plastic parts.

### Care of the Li-ion batteries

- Keep the battery free from oil and grease.
- Use only a slightly damp cloth to clean the casing. Do not use cleaning agents containing silicone as these may attack the plastic parts.
- Avoid ingress of moisture.

### Maintenance

- Check all visible parts and controls for signs of damage at regular intervals and make sure that they all function correctly.
- Do not operate the cordless tool if signs of damage are found or if parts malfunction. Have the tool repaired by **Hilti Service** immediately.
- After cleaning and maintenance, fit all guards or protective devices and check that they function correctly.



To help ensure safe and reliable operation, use only genuine Hilti spare parts and consumables. Spare parts, consumables and accessories approved by Hilti for use with the product can be found at your local **Hilti Store** or online at: [www.hilti.group](http://www.hilti.group) | USA: [www.hilti.com](http://www.hilti.com)

## 7.2 Cleaning the inside of the nosepiece

1. Remove the fastener guide. → page 10
2. Clean the inside of the nosepiece.
3. Insert the fastener guide. → page 10

## 8 Transport and storage of cordless tools

### Transport

#### CAUTION

#### Accidental starting during transport !

- ▶ Always transport your products with the batteries removed!
- ▶ Remove the battery.
- ▶ Transport the tool and batteries individually packaged.
- ▶ Never transport batteries in bulk form (loose, unprotected).
- ▶ Check the tool and batteries for damage before use after long periods of transport.

### Storage

#### CAUTION

#### Accidental damage caused by defective or leaking batteries !

- ▶ Always store your products with the batteries removed!
- ▶ Store the tool and batteries in a place that is as cool and dry as possible.
- ▶ Never store batteries in direct sunlight, on heating units or behind a window pane.
- ▶ Store the tool and batteries in a place where they cannot be accessed by children or unauthorized persons.
- ▶ Check the tool and batteries for damage before use after long periods of storage.

## 9 Troubleshooting

If the trouble you are experiencing is not listed in this table or you are unable to remedy the problem by yourself, please contact **Hilti Service**.

| Trouble or fault   | Possible cause                       | Action to be taken          |
|--|--------------------------------------|-----------------------------|
| The spring element is not tensioned; no status indication. | The battery is empty.                | ▶ Change the battery.       |
|  | The battery is not fitted correctly. | ▶ Fit the battery. → page 9 |

| Trouble or fault   | Possible cause                                     | Action to be taken   |
|--|--|--|
| There is a delay before the spring mechanism is tensioned, the status indicator flashes blue and a signal tone is emitted simultaneously; the status indicator then lights blue for 6 minutes. | The magazine is empty.                             | ▶ Load the magazine. → page 11                                     |
| The spring element is not tensioned, the status indicator flashes green and 1 battery charge status LED flashes.   | The battery is empty.                              | ▶ Change the battery.  |
|  | Battery temperature too low.                       | ▶ Allow the battery to warm up slowly to room temperature.         |
| The spring element is not re-tensioned, the status indicator flashes green and 4 battery charge status LEDs flash.   | The fastening tool has overheated.                 | ▶ Allow the fastening tool to cool down.                           |
| The spring element is not tensioned and the status indicator flashes red.  | The fastener guide is not fitted correctly.        | ▶ Insert the fastener guide. → page 10                             |
| The spring element is not tensioned and the status indicator lights red.   | System fault.                                      | ▶ Remove the battery. → page 10                                    |
|  |  | ▶ Fit the battery. → page 9  |
| The fastener guide cannot be pressed in and the status indicator lights green.   | The magazine is empty.                             | ▶ Load the magazine. → page 11                                     |
|  | The nail pusher is jammed.                         | ▶ Remove the nail strips from the magazine and clean the magazine. |
|  | Nail jammed in the fastener guide.                 | ▶ Release the jammed nail. → page 14                               |
| The fastener guide is jammed in the pressed-in state.  | Dirt between the fastener guide and the nosepiece. | ▶ Clean the inside of the nose-piece. → page 15                    |

## 10 Disposal

Most of the materials from which **Hilti** tools and appliances are manufactured can be recycled. The materials must be correctly separated before they can be recycled. In many countries, your old tools, machines or appliances can be returned to **Hilti** for recycling. Ask **Hilti** Service or your Hilti representative for further information.

### Battery disposal

Improper disposal of batteries can result in health hazards from leaking gases or fluids.

- ▶ DO NOT send batteries through the mail!
- ▶ Cover the terminals with a non-conductive material (such as electrical tape) to prevent short circuiting.
- ▶ Dispose of your battery out of the reach of children.
- ▶ Dispose of the battery at your **Hilti Store**, or consult your local governmental garbage disposal or public health and safety resources for disposal instructions.



- ▶ Do not dispose of power tools, electronic equipment or batteries as household waste!

## 11 RoHS (Restriction of Hazardous Substances)

Click on the link to go to the table of hazardous substances: [BX3 qr.hilti.com/r7775899](https://qr.hilti.com/r7775899) BX3-L [qr.hilti.com/r7775857](https://qr.hilti.com/r7775857).

There is a link to the RoHS table, in the form of a QR code, at the end of this document.

## 12 Manufacturer's warranty

- ▶ Please contact your local **Hilti** representative if you have questions about the warranty conditions.



**Hilti Corporation**  
Feldkircherstraße 100  
9494 Schaan | Liechtenstein

**BX 3 (02), BX 3-L (02)**

[2018]

2006/42/EC

EN ISO 12100

2014/53/EU

EN 60745-1

2011/65/EU

EN 60745-2-16

Schaan, 06 / 2018

A handwritten signature in black ink, appearing to read "N. Wohlwend".

**Norbert Wohlwend**

Head of Quality and  
Process-Management  
BU Direct Fastening

A handwritten signature in black ink, appearing to read "Lars Taenzer".

**Lars Taenzer**

Head of BU Direct Fastening

BX3



BX3-L







Hilti Corporation  
LI-9494 Schaan  
Tel.: +423 234 21 11  
Fax: +423 234 29 65  
[www.hilti.group](http://www.hilti.group)



2164701



Hilti Connect